



# INSTALLATION TOOLS

**PIPE CUTTERS**  
FOR STEEL AND CAST  
IRON PIPES  
>598



**PIPE CUTTERS / PIPE  
DEBURRING REAMER**  
FOR STAINLESS STEEL  
PIPES  
>600



**PIPE CUTTERS / PIPE  
DEBURRING REAMER /  
CALIBRATING TOOL**  
FOR COPPER PIPES  
>602



**PIPE CUTTERS**  
FOR PLASTIC PIPES  
>604



**FLARING TOOLS**  
>606



**INSTALLATION TOOLS**  
>609



## Installation Tools

# APPLICATIONS OF THE GEDORE PIPE CUTTERS

	No. 210015	No. 2180..	No. 220...	No. 222...	No. 2250 3	No. 226100	No. 2268..	No. 2270..	No. 2300..	No. 2303..	No. 231000	No. 231011
Steel pipes EN 10255	3"-12"		1/8-2" (220020)	1/8-2" (222020)								
Steel pipes EN 10220			1.1/4-4" (220040)	1.1/4-4" (222040)								
Cast iron pipes EN 545, SML pipes EN 877	DN 80-300		DN 6-32 (220020) DN 32-100 (220040)	DN 6-32 (222020) DN 32-100 (222040)								
Electrical installation pipes EN 60423		M 12-32 (2180 3) M 12-40 (2180 4) M 12-63 (2180 5)								M 12-32 (230311) M 16-63 (230321)		M 12-16
Multi-layer composite pipes							≤ 42 mm (2268 2) ≤ 63 mm (2268 3)	6-76 mm (2270 5) 50-127 mm (2270 6)				
Plastic pipes					16, 19, 25 mm		≤ 42 mm (2268 2) ≤ 63 mm (2268 3)	6-76 mm (2270 5) 50-127 mm (2270 6)				
Copper pipes EN 1057		3-35 mm (2180 3)										
Sheated copper pipes		3-45 mm (2180 4)			3-35 mm				4-32 mm (230010) 13-65 mm (230020)	4-32 mm (230311) 13-65 mm (230321)	4-16 mm	4-16 mm
Thin-walled NF pipes		6-76 mm (2180 5)										
Hydraulic pipes EN 10305-1 (DIN 2391)		3-35 mm (2180 3)	10-42 mm (220020)	10-42 mm (222020)					4-32 mm (230010) 13-65 mm (230020)	4-32 mm (230311) 13-65 mm (230321)	4-16 mm	4-16 mm
Precision steel pipes EN 10305-3 (DIN 2394)		3-45 mm (2180 4) 6-76 mm (2180 5)	42-114 mm (220040)	42-114 mm (222040)	3-35 mm							
Stainless steel pipes EN 10088-3 (DIN 17 440)		3-35 mm (2180 3) 3-45 mm (2180 4) 6-76 mm (2180 5)	10-42 mm (220020 + 220221)	10-42 mm (222020 + 220221)						4-32 mm (230311) 13-65 mm (230321)		4-16 mm

\*) depending on size / finish / pipe properties

## Pipe Cutters for steel and cast iron pipes

### 210 LINK PIPE CUTTER

for steel, SML and cast iron pipes

- > Low space requirements due to ratchet-type operation
- > In the standard version suitable for pipes from 85 to 175 mm Ø
- > Can be extended if needed with extension set no. 210100, see table "Cutting range link pipe cutter no. 210015"
- > Enamelled blue



Ø mm	Wall thickness	kg	Code	No.
85-175	3,2-8,0	5.7	4536250	210015

### CUTTING RANGE OF THE LINK PIPE CUTTER NO. 210015

Cutting range from min. Internal Ø mm to max. External Ø mm	Number of cutting wheels	Accessories required
85 - 115	3*	
110 - 145	4*	
135 - 175	5	
165 - 200	6	1 x 210100
190 - 225	7	2 x 210100
220 - 250	8	3 x 210100
240 - 280	9	4 x 210100
270 - 300	10	5 x 210100
295 - 330	11	6 x 210100

\* the link pipe cutter must be reduced by the corresponding number of cutting wheels

### E 210 EXTENSION KIT

- > For extending the cutting range at No. 210015
- > For more information see table "Cutting range link pipe cutter no. 210015"

Contents	kg	Code	No.
<b>1 Cutting wheel for steel No. 210200</b>	0.400	2799626	210100
<b>1 Spare link No. 210500</b>			
<b>1 Spare bolt No. 210600</b>			

### E 210 SPARE PARTS

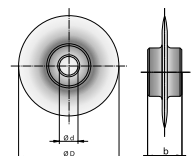

Description	Ø D	b	Ø d	kg	Code	No.
<b>Cutting wheel for 210015</b>	50	11	11	0.080	4536410	210200
<b>Spare link for 210015</b>				0.290	4551480	210500
<b>Spare bolt for 210015</b>				0.027	4536680	210600

## 220

### PIPE CUTTER TUBEX

for steel, SML and cast iron pipes

- > Heavy-duty pipe cutter with 1 cutting wheel
- > By exchanging the cutting wheels, may also be used for stainless steel pipes (size 2")
- > Frame in malleable cast steel
- > With elastic feed using especially-installed spring system (size 2")
- > Spindle protected by sleeve extension
- > Enamelled blue, spindle gun-metal finished

Version with 3 cutting wheels see no. 222



Size	Ø mm	Wall thickness	l- mm -l	⌀ kg	Code	No.
1/8-2	10-60	2,0-6,3	380	2.9	4503400	220020
1.1/4-4	42-114	2,6-8,0	520	5.0	4503590	220040

## 222

### PIPE CUTTER TUBEX

for steel, SML and cast iron pipes

- > Heavy-duty pipe cutter with 3 cutting wheels
- > Ideal for working in confined, hard-to-reach places, since the cutter does not need to be turned through 360°
- > By exchanging the cutting wheels, may also be used for stainless steel pipes (size 2")
- > Frame in malleable cast steel
- > With elastic feed using especially-installed spring system (size 2")
- > Spindle protected by sleeve extension
- > Enamelled blue, spindle gun-metal finished



Size	Ø mm	Wall thickness	l- mm -l	⌀ kg	Code	No.
1/8-2	10-60	2,0-6,3	380	2.7	4537060	222020
1.1/4-4	42-114	2,6-8,0	520	4.8	4553420	222040

## E 220 - E 222

### SPARE PARTS

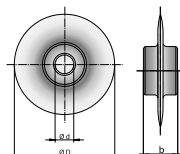

Description	Ø D	b	Ø d	⌀ kg	Code	No.
Cutting wheel for 220020, 222020	32	19	9	0.028	4503750	220220
Cutting wheel for niro for 220020, 222020	32	19	9	0.028	1524038	220221
Cutting wheel for 220040, 222040	41	19	9	0.038	4503830	220240
Wheel bolt for 220020, 222020				0.015	4552450	220620
Wheel and pressure roller bolt for 220040, 222040				0.019	4552530	220640



## Pipe Cutters for stainless steel pipes

### 2180 PIPE CUTTER

for stainless steel pipes

- > Easy cutting due to ball-bearing pressure rollers and cutting wheels
- > Cutting wheel changeable without tools
- > With retractable deburring tool, spare cutting wheel in handle
- > Cutting wheel with high service life

- > No. 2180 3 and 2180 4 body in pressure-cast magnesium, no. 2180 5 body in pressure-cast aluminium
- > No. 2180 5 with quick-release
- > Enamelled blue



Ø mm	Wall thickness	l mm	kg	Code	No.
3-35	0,7-2,5	160	0.335	2964066	2180 3
3-45	0,7-2,5	180	0.355	2964074	2180 4
6-76	0,7-2,5	245	0.880	2964082	2180 5

### E 2180 SPARE PARTS



Description	Ø D	b	Ø d	kg	Code	No.
<b>Cutting wheel for 2180 3, 2180 4</b>	20	5.1	4.8	0.005	2964090	E-2180 3 A
<b>Cutting wheel for 2180 5</b>	20	6.2	4.8	0.008	2964104	E-2180 5 A
<b>Wheel bolt for 2180 3, 2180 4, 2250 3</b>				0.002	2964112	E-2180 3 B
<b>Wheel bolt for 2180 5, 2270 5</b>				0.005	2964120	E-2180 5 B

### 2303 PIPE CUTTER QUICK AUTOMATIC NIRO

for stainless steel pipes

- > Body in pressure-cast zinc
- > Cutting wheel made from high-alloy stainless steel, with high service life

- > Automatic infeed by plate springs
- > Enamelled blue

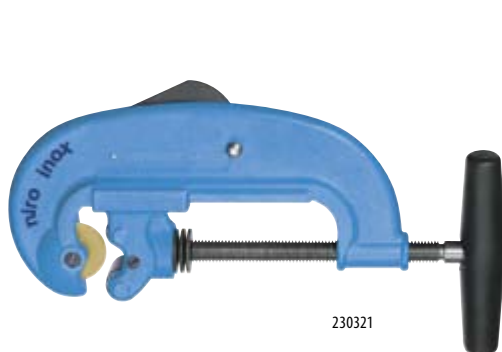

Ø mm	Wall thickness	l mm	kg	Code	No.
4-32	0,7-3,0	165	0.430	1154990	230311
13-65	1,0-3,0	275	1.420	1154850	230321

### E 2303 SPARE PARTS

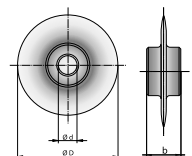

Description	Ø D	b	Ø d	kg	Code	No.
<b>Cutting wheel for stainless steel</b>	20	4.8	5.1	0.005	1154710	230411
<b>Cutting wheel for stainless steel</b>	32	9.9	6.1	0.018	1154680	230421
<b>Wheel bolt</b>				0.003	1154656	230611
<b>Wheel bolt</b>				0.003	1154540	230621

# 231011

## MINIATURE PIPE CUTTER MINI-QUICK NIRO

for stainless steel pipes

- > Particularly suitable for barely accessible places
- > Body in pressure-cast zinc
- > Cutting wheel with high service life
- > Enamelled blue



Ø mm	Wall thickness	↳ mm ↲	⚖	Code	No.
4-16	0,7-2,0	50	0.125	4554070	231011

# E 231011

## SPARE PARTS

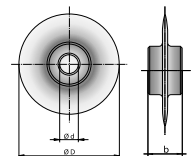

Description	Ø D	b	Ø d	⚖	Code	No.
<b>Cutting wheel for stainless steel</b>	20	4.8	5.1	0.005	1154710	230411
<b>Wheel bolt</b>				0.003	1154656	230611

## Pipe Deburring Reamer for stainless steel pipes

# 2325

## PIPE DEBURRING REAMER

for stainless steel pipes

- > For internal and external deburring of stainless steel pipes
- > Aluminium body
- > Hardened taper section with 40 deburring blades



Ø mm	↳ mm ↲	⚖	Code	No.
8-35	60	0.180	1857681	232501
10-56	85	0.420	1419684	232500

224011 / 224021

>546



4589

>546



## Pipe Cutters for copper pipes

**NEW**

### 2250 PIPE CUTTER

for copper pipes

- > For copper, brass, and light-alloy pipes, PVC hard plastic and plastic-coated pipes, thin-walled steel pipes, (precision steel and hydraulic pipes), composite pipes
- > Cutting wheel changeable without tools
- > With retractable deburring tool, spare cutting wheel in handle

- > Body in pressure-cast magnesium
- > Enamelled blue



Ø mm	Wall thickness	l mm	kg	Code	No.
3-35	0,7-2,0	160	0.335	2964031	2250 3

### E-2250 SPARE PARTS

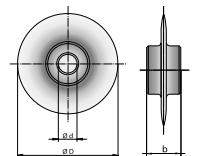

Description	Ø D	b	Ø d	kg	Code	No.
<b>Cutting wheel for 2250 3</b>	20	5.1	4.8	0.005	2964058	E-2250 3 A
<b>Wheel bolt for 2180 3, 2180 4, 2250 3</b>				0.002	2964112	E-2180 3 B

### 2300 PIPE CUTTER QUICK AUTOMATIC

- > Body in pressure-cast zinc
- > For copper, brass, and light-alloy pipes, PVC hard plastic and plastic-coated pipes, thin-walled steel pipes, (precision steel and hydraulic pipes), composite pipes

- > With automatic infeed by plate springs, retractable deburring knife
- > Enamelled blue

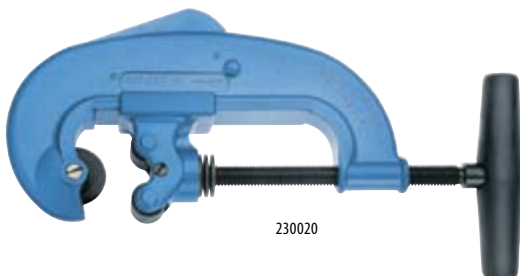

230010

230020

Ø mm	Wall thickness	l mm	kg	Code	No.
4-32	0,7-3,0	165	0.435	4504050	230010
13-65	1,0-7,3	275	1.460	4504130	230020

### E 2300 SPARE PARTS

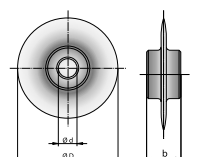

Description	Ø D	b	Ø d	kg	Code	No.
<b>Cutting wheel</b>	20	4.8	5.1	0.005	4504640	230210
<b>Cutting wheel</b>	32	9.9	6.1	0.018	4504800	230220
<b>Wheel bolt</b>				0.003	1154656	230611
<b>Wheel bolt</b>				0.003	1154540	230621

## 2310

### MINIATURE PIPE CUTTER MINI-QUICK

- > Particularly suitable for barely accessible places
- > For copper, brass, and light-alloy pipes, thin-walled steel pipes (precision steel and hydraulic pipes)
- > Body in pressure-cast zinc
- > Enamelled blue



$\varnothing$ mm	Wall thickness	↳ mm ↴	$\frac{kg}{kg}$	Code	No.
4-16	0,7-3,0	50	0.125	4504560	231000

## E 2310

### SPARE PARTS

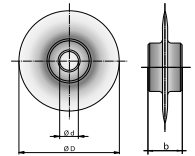

Description	$\varnothing$ D	b	$\varnothing$ d	$\frac{kg}{kg}$	Code	No.
<b>Cutting wheel</b>	20	4.8	5.1	0.005	4504640	230210
<b>Wheel bolt</b>				0.003	1154656	230611

### Pipe Deburring Reamer for copper pipes

### Calibrating Tools for copper pipes

## 2320

### PIPE DEBURRING REAMER

- > For hydraulic and precision steel pipes, copper pipes, as well as pipes in non-ferrous metals
- > For internal and external deburring
- > Plastic body



$\varnothing$ mm	↳ mm ↴	$\frac{kg}{kg}$	Code	No.
4-32	45	0.030	1439510	232001

## 239

### CALIBRATING TOOL

- > For exact calibrating of tube ends
- > For semi-hard and soft copper pipes
- > Gun-metal finish



$\varnothing$ mm	$\frac{kg}{kg}$	Code	No.
12 x 1	0.067	4506340	239012
15 x 1	0.138	4506420	239015
18 x 1	0.179	4506500	239018
22 x 1	0.270	4506690	239022





## Pipe Cutters for plastic pipes

# 2270 PIPE CUTTER

for plastic and composite pipes

- > To cleanly cut multi-layer composite pipes or other plastic pipes
- > Cutting wheel changeable without tools
- > With retractable deburring tool, spare cutting wheel in handle
- > No. 2270 5 with adjustable third pressure roller for optimally guiding different pipe dimensions
- > With quick-release
- > Body in pressure-cast aluminium
- > Enamelled blue



2270 6



2270 5

Ø mm	Wall thickness	l mm	kg	Code	No.
6-76	1,5-8,6	245	0.880	2964015	2270 5
50-127	4,0-19,8	345	1.630	2963957	2270 6

## E-2270 SPARE PARTS

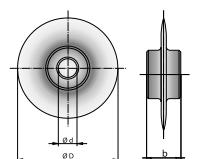

Description	Ø D	b	Ø d	kg	Code	No.
<b>Cutting wheel for 2270 5</b>	30	6.2	4.8	0.008	2964023	E-2270 5 A
<b>Cutting wheel for 2270 6</b>	51	11.0	8.1	0.015	2963973	E-2270 6 A
<b>Wheel bolt for 2180 5, 2270 5</b>				0.005	2964120	E-2180 5 B
<b>Wheel bolt for 2270 6</b>				0.010	2963981	E-2270 6 B

## 2261 SHEARS SET

for plastic pipes

> To cleanly cut hard and soft plastic pipes, rubber hoses with or without textile reinforcement, and as well as various plastic profiled sections, such as cable ducts, for example

> Contains form blocks for 16, 19 and 25 mm pipes, 1 prism for profiles and 1 angle stop adjustable up to 45°  
> Delivery in plastic case



### E 2261 SPARE PARTS

Description		Code	No.
Shear set for plastic pipes	1.050	1637983	226100

Description		Code	No.
Spare knife	0.050	1680137	226005

## 2268 PIPE SHEARS

for plastic pipes

> Suitable to cut PE-, PP-, PB-, PEX-, PPR-, MLP-/MSR-, VPE-, CPVC-, PVC- and PVDF-pipes  
> Can also be used for hoses  
> Smooth and accurate cutting, one hand operation

> Cutting blades changeable without tools  
> Body in pressure-cast magnesium  
> Enamelled blue



### E-2268 SPARE PARTS



∅ mm	l mm		Code	No.
42	245	0.430	2963841	2268 2
63	280	0.610	2963892	2268 3

Description		Code	No.
Spare knife for 2268 2	0.080	2963914	E-2268 2 A
Spare knife for 2268 3	0.160	2963930	E-2268 3 A
Spare bolt for 2268 2 / 3	0.005	2963949	E-2268 B



## Flaring Tools

# 2330 FLARING TOOL BOERDEX

- > For flaring copper and light-alloy pipes of various hardnesses
- > For cooling systems and refrigeration technique
- > Body in pressure-cast zinc, enamelled blue
- > Flange cone 90° hardened = 45° angled from pipe
- > Clamping jaws made from steel, smooth inside, phosphated
- > Opening angle 90° = 45° angled from pipe

Flaring tools for brake lines see no. 1101-2340



Contents	⚖️	Code	No.
for metric pipes 4, 4.75, 6, 8, 10, 12, 14 mm 1 flaring tool No. 233000 1 cone for 180° flaring No. 233200 1 clamping jaw 4-14 mm No. 233101	1.4	4537300	233001
for metric pipes 15, 16, 17, 18, 19 mm 1 flaring tool No. 233000 1 cone for 180° flaring No. 233200 1 clamping jaw 15-19 mm No. 233109	1.4	1919725	233009
for inch pipes 3/16, 1/4, 5/16, 3/8, 7/16, 1/2, 5/8, 3/4" 1 flaring tool No. 233000 1 cone for 180° flaring No. 233200 1 clamping jaw 3/16-3/4" No. 233107	1.5	4554660	233007

Contents	⚖️	Code	No.
for metric pipes 4, 4.75, 6, 8, 10, 12, 14 mm for inch pipes 3/16, 1/4, 5/16, 3/8, 7/16, 1/2, 5/8, 3/4" 1 flaring tool No. 233000 1 cone for 180° flaring No. 233200 1 clamping jaw 4-14 mm No. 233101 1 clamping jaw 3/16-3/4" No. 233107	2.1	2926741	233013
for metric pipes 4, 4.75, 6, 8, 10, 12, 14, 15, 16, 17, 18, 19 mm 1 flaring tool No. 233000 1 cone for 180° flaring No. 233200 1 clamping jaw 4-14 mm No. 233101 1 clamping jaw 15-19 mm No. 233109	2.0	2926768	233014

CONE 90°

CONE 180°

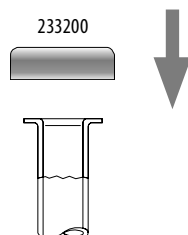
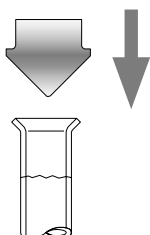

920

>565



# 1101-2333

## FLARING TOOL SET BOERDEX

in i-BOXX® 72

- > For flaring copper and light-alloy pipes of various hardnesses
- > For cooling systems and refrigeration technique
- > Body in pressure-cast zinc, enamelled blue
- > Flange cone 90° hardened = 45° angled from pipe
- > With cone for 180° flaring = 90° angle from pipe
- > Clamping jaws made from steel, smooth inside, phosphated
- > Complete set for metric and metric/inch pipes
- > With pipe cutter 3-35 mm Ø
- > Delivery in GEDORE i-BOXX® 72 no. 1101 L
- > Dimensions: W 367 x D 316 x H 72 mm

Flaring tools for brake lines see no. 1101-2340



Contents	⚖️	Code	No.
for metric pipes 4, 4.75, 6, 8, 10, 12, 14 mm	2.9	4555550	1101-233301
1 flaring tool No. 233000			
1 clamping jaw 4-14 mm No. 233101			
1 pipe cutter 4-32 mm No. 230010			
1 cone 180° No. 233200			
1 sheet steel case No. 233909			
for metric pipes 15, 16, 17, 18, 19 mm	2.9	1919733	1101-233309
1 flaring tool No. 233000			
1 clamping jaw 15-19 mm No. 233109			
1 pipe cutter 4-32 mm No. 230010			
1 cone 180° No. 233200			
1 sheet steel case No. 233909			
for inch pipes 3/16, 1/4, 5/16, 3/8, 7/16, 1/2, 5/8, 3/4"	3.0	4556280	1101-233307
1 flaring tool No. 233000			
1 clamping jaw 3/16-3/4" No. 233107			
1 pipe cutter 4-32 mm No. 230010			
1 cone 180° No. 233200			
1 sheet steel case No. 233909			

Contents	⚖️	Code	No.
for metric pipes 4, 4.75, 6, 8, 10, 12, 14 mm	3.6	2926776	1101-233313
for inch pipes 3/16, 1/4, 5/16, 3/8, 7/16, 1/2, 5/8, 3/4"			
1 flaring tool No. 233000			
1 clamping jaw 4-14 mm No. 233101			
1 clamping jaw 3/16-3/4" No. 233107			
1 pipe cutter 4-32 mm No. 230010			
1 cone 180° No. 233200			
1 sheet steel case No. 233909			
for metric pipes 4, 4.75, 6, 8, 10, 12, 14, 15, 16, 17, 18, 19 mm	3.5	2926784	1101-233314
1 flaring tool No. 233000			
1 clamping jaw 4-14 mm No. 233101			
1 clamping jaw 15-19 mm No. 233109			
1 pipe cutter 4-32 mm No. 230010			
1 cone 180° No. 233200			
1 sheet steel case No. 233909			

## E 233

### PARTS



2331



233200

Description	⚖️	Code	No.
Flaring tool boerdex	0.660	4554150	233000
Clamping jaw 4-14 mm	0.620	4554820	233101
Clamping jaw 15-19 mm	0.560	1885162	233109
Clamping jaw 3/16" - 3/4"	0.680	4555470	233107
Cone for 180° flaring (= 90° angled from pipe)	0.015	4505450	233200
Pipe cutter for copper pipes 3-35 mm	0.335	2964031	2250 3



# 1101-2340 DOUBLE FLARING TOOL SET

in i-BOXX® 72

- > For standard-compliant (DIN 74234) double flaring tools
- > For brake lines, coolant lines, hydraulic and pneumatic pipes with a wall thickness of 0.7 to 1.0 mm
- > Body in tempered cast iron GTW 40, stove enamelled blue
- > Clamping jaws made from steel, smooth inside, phosphated
- > Complete set for metric and/or inch pipes
- > With pipe deburring reamer 4-32 mm Ø and miniature pipe cutter 4-16 mm Ø
- > Delivery in GEDORE i-BOXX® 72 No. 1101 L
- > Dimensions: W 367 x D 316 x H 72 mm



Contents	Weight	Code	No.
<b>for metric pipes</b>	3.0	4505530	1101-234001
1 basic frame No. 234000			
1 clamping jaw metric No. 234101			
6 cones 4,75-10 mm No. 234204-234210			
2 cones, No. 234790 + 234801			
1 miniature pipe cutter 4-16 mm No. 231000			
1 pipe deburring reamer 4-32 mm No. 232001			
1 GEDORE i-BOXX® 72 No. 1101 L			

Contents	Weight	Code	No.
<b>for metric + inch pipes</b>	4.2	4662980	1101-234013
1 basic frame No. 234000			
2 clamping jaws No. 234101 + 234102			
6 cones 4,75-10 mm No. 234204-234210			
4 cones 3/16-3/8" No. 234303-234306			
3 cones No. 234790 + 234801-802			
1 miniature pipe cutter 4-16 mm No. 231000			
1 pipe deburring reamer 4-32 mm No. 232001			
1 GEDORE i-BOXX® 72 No. 1101 L			

## CONE 90°

## CONE 180°

## FLARE F OPEN

## FLARE E DOUBLE

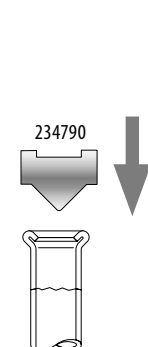
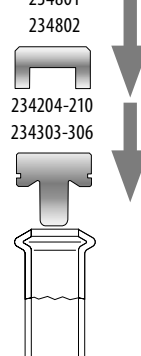
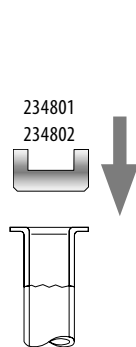
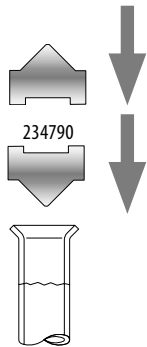

## E 2340 PARTS



Description	Weight	Code	No.
<b>Basic frame</b>	0.880	4556440	234000
<b>Clamping jaw metric</b>	0.760	4556520	234101
<b>Clamping jaw inch</b>	0.760	4556600	234102
<b>Cone 4,75 mm for flare types E + F</b>	0.018	4556790	234204
<b>Cone 5 mm for flare types E + F</b>	0.018	4556870	234205
<b>Cone 6 mm for flare types E + F</b>	0.018	4556950	234206
<b>Cone 8 mm for flare types E + F</b>	0.018	4557090	234208
<b>Cone 9 mm for flare types E + F</b>	0.018	4557170	234209
<b>Cone 10 mm for flare types E + F</b>	0.018	4557250	234210
<b>Cone 3/16" for flare types E + F</b>	0.018	4557330	234303
<b>Cone 1/4" for flare types E + F</b>	0.018	4557410	234304

Description	Weight	Code	No.
<b>Cone 5/16" for flare types E + F</b>	0.018	4557680	234305
<b>Cone 3/8" for flare types E + F</b>	0.018	4557760	234306
<b>Cone (adjustment gauge) for flare types 90° + 180° and cone 90° + flare E</b>	0.016	4557840	234790
<b>Cone (adjustment gauge), metric, 180°, for flare types E + F</b>	0.011	4557920	234801
<b>Cone (adjustment gauge), inch, 180°, for flare types E + F</b>	0.011	4558060	234802
<b>Pipe cutter MINI-QUICK, 4-16 mm</b>	0.125	4504560	231000
<b>Pipe deburring reamer 4-32 mm</b>	0.030	1439510	232001



## Installation Tools

### 312 VALVE HOLDER VENTI-QUICK

- > In aluminium
- > Drain valve holder and screw-in wrench for eccentric and standard valves 1.1/4"
- > Usable from top or bottom



↳ mm ↳	⚖️	Code	No.
120	0.255	4508980	312000

### 314 CORNER VALVE SOCKET WRENCH

- > Chrome-vanadium steel 31CrV3, hardened, zinc-plated
- > For surface-protective assembling of all usual corner valves
- > With chamfered driving edges
- > 1/2" internal square drive

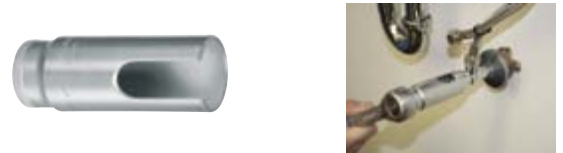

↳ mm ↳	internal Ø	⚖️	Code	No.
82	27	0.150	1147471	314000

### 3170 INSTALLATION WRENCH

- > For washbasin mountings
- > With moveable stud screw insert for bathroom fittings attachment M10 or M12
- > Open end spanner size 17x19 mm for tightening or loosening of corner valves



for stud screws	Size	↳ mm ↳	⚖️	Code	No.
<b>M10</b>	17x19 mm	250	0.330	4509360	317000
<b>M12</b>	17x19 mm	250	0.330	4609310	317012

### 3175 INSTALLATION WRENCH

- > For washbasin mountings
- > With moveable stud screw insert for bathroom fittings attachment M10 or M12
- > With reversible ring ratchet size 17 mm for tightening or loosening of bathroom fittings connections even in hard-to-reach areas
- > Open end spanner size 19 mm for tightening or loosening of corner valves
- > GEDORE vanadium steel 31CrV3, matt chrome-plated



for stud screws	Size	↳ mm ↳	⚖️	Code	No.
<b>M10</b>	17x19 mm	250	0.330	4509520	317500
<b>M12</b>	19x19 mm	250	0.330	4609580	317512

### 3171 STUD SCREW WRENCH

- > For bathroom fittings attachment (stud screws) M6, M8, M10, M12
- > With pivotable thread insert
- > Nickel-plated



↳ mm ↳	⚖️	Code	No.
220	0.300	4509440	317100

### 3173 STUD SCREW INSERTER

- > Self-gripping
- > For the fast and easy insertion and removal of studs, bolts, etc.
- > With hexagon drive



Size	⚖️	Code	No.
<b>M6</b>	0.130	1523171	317306
<b>M8</b>	0.130	1523198	317308
<b>M10</b>	0.130	1523201	317310
<b>M12</b>	0.130	1523228	317312



## 3165 BASIN WRENCH

- > For single lever taps and taps with central screw connection up to size 36 mm
- > With 13 mm hexagon drive and additional adaptors for 9, 10, 11 and 14 mm
- > With pivoted hook for right or left hand operation
- > Enamelled blue

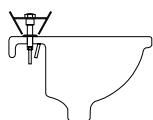

↳ mm	kg	Code	No.
260	0.410	2829274	316500

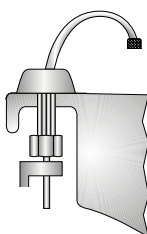

## 320 WRENCH FOR PLUMBING FITTINGS

- > With pawl clamp
- > With exchangeable plastic jaws no. 320100, width 8 mm
- > For nickel-plated and chrome-plated fittings
- > Chrome-vanadium steel 31CrV3, hardened, chrome-plated
- > Handle enamelled blue



mm	mm	↳ mm	kg	Code	No.
65	45	275	0.720	4509600	320000

Description	kg	Code	No.
Set of plastic jaws	0.010	4540520	320100

## 126 STRAP WRENCH

- > Very gentle to surfaces, particularly suitable for chrome-plated fittings and polished surfaces
- > Handle in light metal, enamelled blue
- > With high-strength nylon strap



Ø mm	Ø inch	↳ mm	mm	kg	Code	No.
220	8	300	27	0.325	1468308	126008

## 329 SPECIAL SIPHON PLIERS

- > For tightening and removing screwed PVC pipe joints with round union nuts
- > With lap joint and three locking positions, jaw width 10 mm
- > No. 329001 with plastic jaws for special surface protection
- > Enamelled blue



329000



329001

Ø mm	↳ mm	kg	Code	No.
20-65	230	0.300	4510290	329000
20-65	230	0.300	1984381	329001

## E 126 SPARE STRAP

- > High-strength nylon strap



↳ mm	mm	kg	Code	No.
950	27	0.035	1468316	126208

## 376 STEPPED KEY

- > For the installation and removal of valve nipples 3/8", 1/2", 3/4", 1", 1.1/4"
- > Drive with 18 mm square
- > Enamelled blue



kg	Code	No.
0.245	4541250	376100

## 380 COMBINATION STEPPED KEY

- > For the installation and removal of radiator valves, runback screwed unions 3/8" - 1" and short tap extensions
- > With pin, hexagon and bi-hexagon nut drive
- > 1/2" square drive
- > Nickel-plated



380200

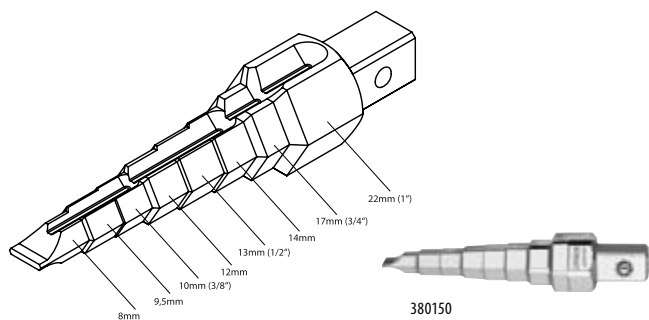

380150

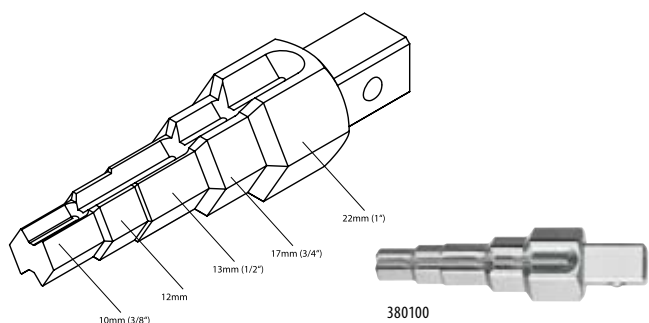

380100

Description	kg	Code	No.
<b>Combi-stepped key No. 380100 with ratchet 1/2" No. 380200</b>	0.555	4512900	380000
<b>Combi-stepped key No. 380150 with ratchet 1/2" No. 380200</b>	0.555	4630940	380001
<b>Combi-stepped key with 5 steps 3/8"-1"</b>	0.135	4513040	380100
<b>Combi-stepped key with 8 steps</b>	0.135	4611130	380150
<b>Ratchet 1/2"</b>	0.420	4513120	380200

## 3785 PLUMBER'S WRENCH

- > With 14 functions for tap extensions 3/8", 1/2", 3/4", 1"
- > Depth up to 100 mm
- > For the installation and removal of radiator valves and runback screwed unions
- > For stud screws M6, M8, M10, M12 and for screw plugs 3/8", 1/2"
- > Hexagon drive nut size 17, 22 mm
- > Chrome-plated

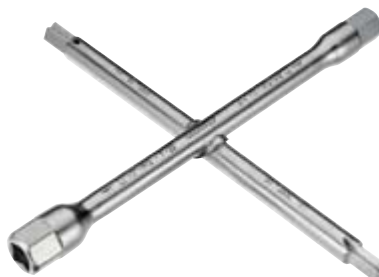

mm	kg	Code	No.
220 x 220	0.670	4512820	378500

## 3810 RADIATOR VALVE SPANNER

- > Spanner for tightening and removing Euro-cone radiator compression fittings with A/F 30 mm cam lock and hex nuts
- > Short, flat version with ratchet
- > Ratchet facilitates tightening of straight and elbow compression fittings underneath radiators
- > Head end socket for 1/2" extension. The extension is used as a handle and also provides higher torque
- > Side socket for 1/2" extension for working with the ratchet in front of the radiator
- > Socket for no. 3801 combination stepped key 3/4" radiator valve nipples
- > DBGM (= German Utility Patent)



381000



381030



Description	kg	Code	No.
<b>Radiator valve spanner no. 381030 with extension 1/2" no. 1990-5</b>	0.390	2233673	381000
<b>Radiator valve spanner 30 mm</b>	0.225	2233665	381030
<b>Extension 1/2" 125 mm</b>	0.188	6143860	1990-5